

11+ Non-Verbal Reasoning Examples

Which cube on the right could be produced by the given net?

1.

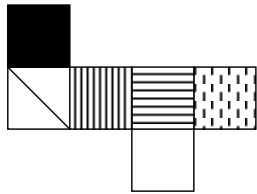

A



B



C



D



E

Where is the shape on the left hidden?

2.

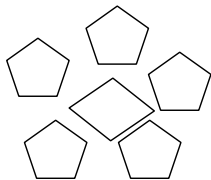

A

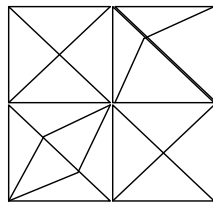

B

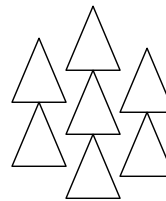

C

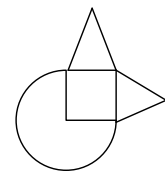

D

Which shape completes the series?

3.

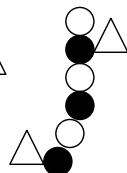
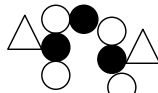
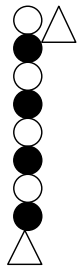
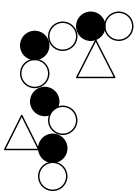

?

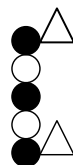

A

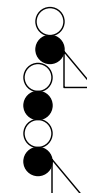

B



C

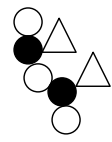

D

Work out the code for the first five shapes, and then write down the code for the final shape.

4.

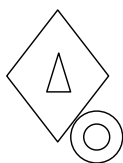

AW

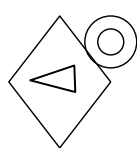

BX

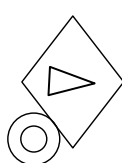

DZ

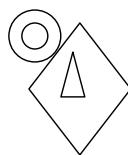

AY

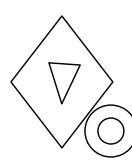

CW

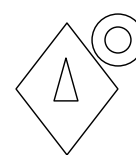

.....?

11+ Non-Verbal Reasoning Examples

Which is the odd one out?

5.

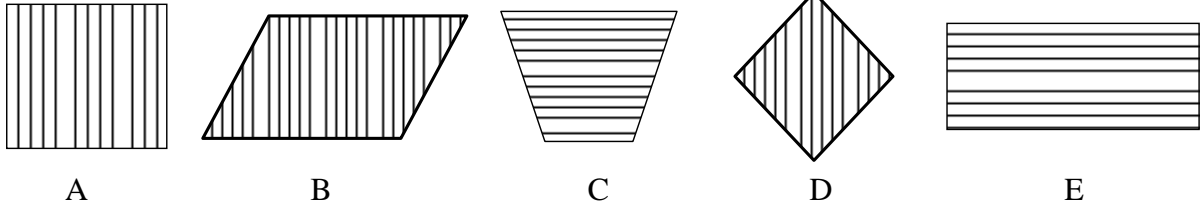

Which shape is the mirror image of the first?

6.

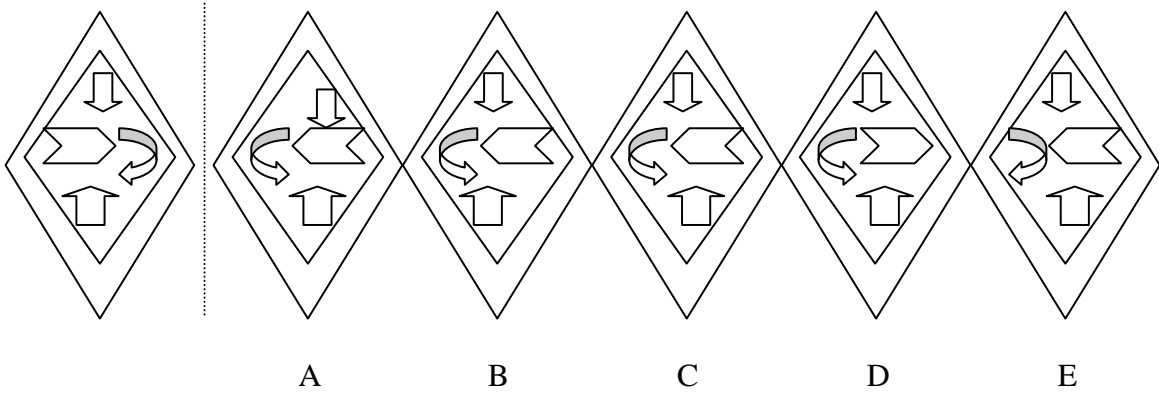

Which shape does not belong with the others?

7.

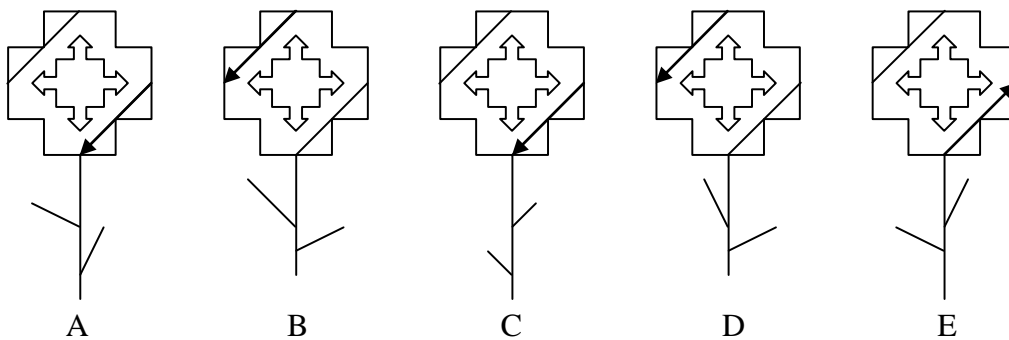

Answers: 1 D 2 A 3 D 4 AX 5 B (no line of symmetry) 6 C 7 E